



Tonino Lamborghini
CASA
HOME CINEMA



Luxury Interiors and Accessories for Exclusive Homes, Hotels, Executive Offices & Yachts
info@formitalia.it www.formitalia.it



HOME CINEMA

Formitalia presents its new home cinema project consisting in the collection Tonino Lamborghini Casa: a customized cinema setting which combines, in perfect harmony, a unique design, an incomparable acoustics and an advanced audio-visual technology in order to live a movie experience like no other.

Among its characteristics, we point out the modular design it was conceived with allowing a customized configuration depending on the precise dimensions of the location where you want to set up the home cinema. A shell shaped structure is envisaged consisting in some pierced panels, made of aluminium, with sandwich acoustic layers which provide a full soundproofing and ensure a perfect sound with the audio components of cinema. It is possible to customize the structure using some high-tech sound absorbent fabrics which are available in a wide range of patterns and colours and the setting is fully air-conditioned.

Inside the YAS armchairs of Tonino Lamborghini Casa collection offer a top-level comfort. They are offered with an upholstering made of very soft leather, available in more than 50 colours, with contrasting trims alternating smooth parts and other parts where an elegant matelassé manufacturing stands out. They are equipped with a space for a refrigerating bottle/tin stand and with a complex electrical mechanism which allows not only a massage but also wide reclining movements of the back and of the footstool which, together with the manual movement of the headrest, allow to enjoy the maximum relax customizing it for individual needs. As far as lightening is concerned, the most recent LED technology is applied, maximizing the energy efficiency without jeopardizing the output and the effect of the flow of light. The stereo system Meridian, configurable with several options and open to several TV systems, offers a full surround system that can be achieved by means of front, side, rear and tilt loudspeakers placed in such a way to provide the perfect sound and the low frequency sound from the four sub-woofers located in the front and rear part of the location. A Barco Balder 'CinemaScope' projector offers incredibly deep, rich and clear images which perfectly match with specifications of the audio loudspeaker. The projection screen is a screen for slide jigs DT Screens Dynamic 2S.

All the technological devices can be controlled remotely: it is possible to update them, the reset them, to repair them by Internet in real time and without the physical intervention of a technician. The Home Cinema by Tonino Lamborghini Casa, Formitalia Luxury Group produces and distributes with a world exclusive, is the solution for those who want the most from technology in a setting where design, luxury and comfort the unquestionable protagonists.

Produced and distributed by

FORMITALIA Luxury Group spa

Headquarters: via Corticella 5/7/9, 51039 Valenzatico (PT), Italy

tel.: +39 0573 790066 fax: +39 0573 734332

Gallery Firenze: Palazzo Nasi, Piazza de'Mozzi 4, 50125 Firenze

info@formitalia.it www.formitalia.it

Tonino Lamborghini
CASA

Formitalia
Luxury Interiors
Firenze - Italia



Produced and distributed by
FORMITALIA Luxury Group spa
Headquarters: via Corticella 5/7/9, 51039 Valenzatico (PT), Italy
tel.: +39 0573 790066 fax: +39 0573 734332
Gallery Firenze: Palazzo Nasi, Piazza de'Mozzi 4, 50125 Firenze
info@formitalia.it www.formitalia.it



Why is CIPOD different?

- Design: your CIPOD is uniquely constructed to an exacting specification, slotting handcrafted luxury and cutting edge technology into the very heart of your home.
- Materials: we collaborate with the world's leading luxury fabrics, textiles, woods and metal manufacturers to enhance your experience with the ultimate in comfort and aesthetics.
- Technology: every CIPOD is equipped with pioneering audio and visual equipment to effortlessly transport you to the limits of your imagination. Remote diagnostics alert us if performance ever falls below optimum, and we can advise our customers of any current available upgrades.
- Flexibility: every CIPOD is constructed from a modular design allowing it to be configured to the exact dimensions of your home.
- Craftsmanship: your pod is handcrafted in the UK, with exquisite attention to detail and precision engineering ensuring that your expectations are always succeeded.
- Speed: why wait to be transported to extraordinary? Unlike other home cinema manufacturers, the CIPOD's unique capsule design allows it to be installed in days, not months – without compromising on craftsmanship or performance.
- Service: complete peace of mind is built in thanks to our comprehensive before, during and after service package.



Tonino Lamborghini
CASA



Formitalia
Luxury Interiors
Firenze - Italia

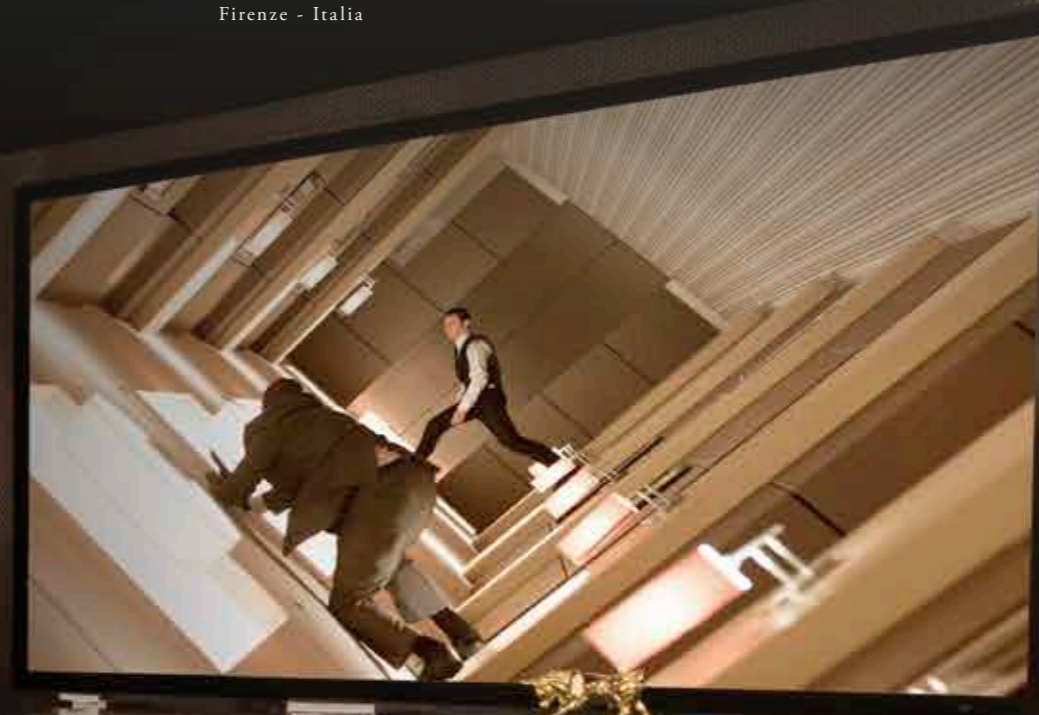

Produced and distributed by
FORMITALIA Luxury Group spa
Headquarters: via Corticella 5/7/9, 51039 Valenzatico (PT), Italy
tel.: +39 0573 790066 fax: +39 0573 734332
Gallery Firenze: Palazzo Nasi, Piazza de'Mozzi 4, 50125 Firenze
info@formitalia.it www.formitalia.it



About the Pod

- The Pod can be slotted into a home anywhere, provided that there is a minimum space available, ideally 5x4x2.5m. It can even be located outside the home as a stand-alone structure (available summer 2018).
- The Pod is free-standing and not attached to the building. This means that there's minimal building disruption to the property. It also means that the client can take the CIPOD with them to their next home should they move.
- The Pod structure is made in strictly-controlled conditions in a factory in the United Kingdom
- The core structure of the Pod is made from aluminium perforated panels that sandwich acoustic layers. The acoustic layers provide complete sound-proofing as well as ensuring perfect sound from the audio components of the cinema.
- The Pod's structure is designed to hide from sight all of the cinema's technology within its shell. This means that the interior design is unspoilt by any unsightly wires, boxes or other paraphernalia.
- Position of audio visual, seating and other technology is based on industry specifications and recommendations (Dolby) to deliver optimum performance and is therefore pre-determined. However, the position of entry doors to the pod is flexible to ensure that they suit the property's layout.
- The Pod's sound-proofed doors may be either single or double, of standard opening or fully automated – activated by a wave-sensor infrared beam.

Tonino Lamborghini
CASA

Formitalia
Luxury Interiors
Firenze - Italia



Produced and distributed by
FORMITALIA Luxury Group spa
Headquarters: via Corticella 5/7/9, 51039 Valenzatico (PT), Italy
tel.: +39 0573 790066 fax: +39 0573 734332
Gallery Firenze: Palazzo Nasi, Piazza de'Mozzi 4, 50125 Firenze
info@formitalia.it www.formitalia.it



CIPOD Finishes

- We have our own unique ranges of 3D acoustic materials. This enables us to achieve amazing interiors without exposing the technology in the pod.
- The pod is available with a standard range of materials, using luxury wool carpets, stretched silk and 3D fabrics from a palette of colours.
- The seating is beautifully and ergonomically designed to provide the ultimate in comfort using luxury fabrics and leather.
- A bespoke interior design solution is of course available, offering the client a wider selection of finishes and fabrics with which to make their CIPOD even more extraordinary.
- Other bespoke fixtures and finishes include custom-made door handles, bespoke designed light fittings and pendants and hand-made 'Jesmonite' tiles to door surrounds and plinths.

Section through Pod

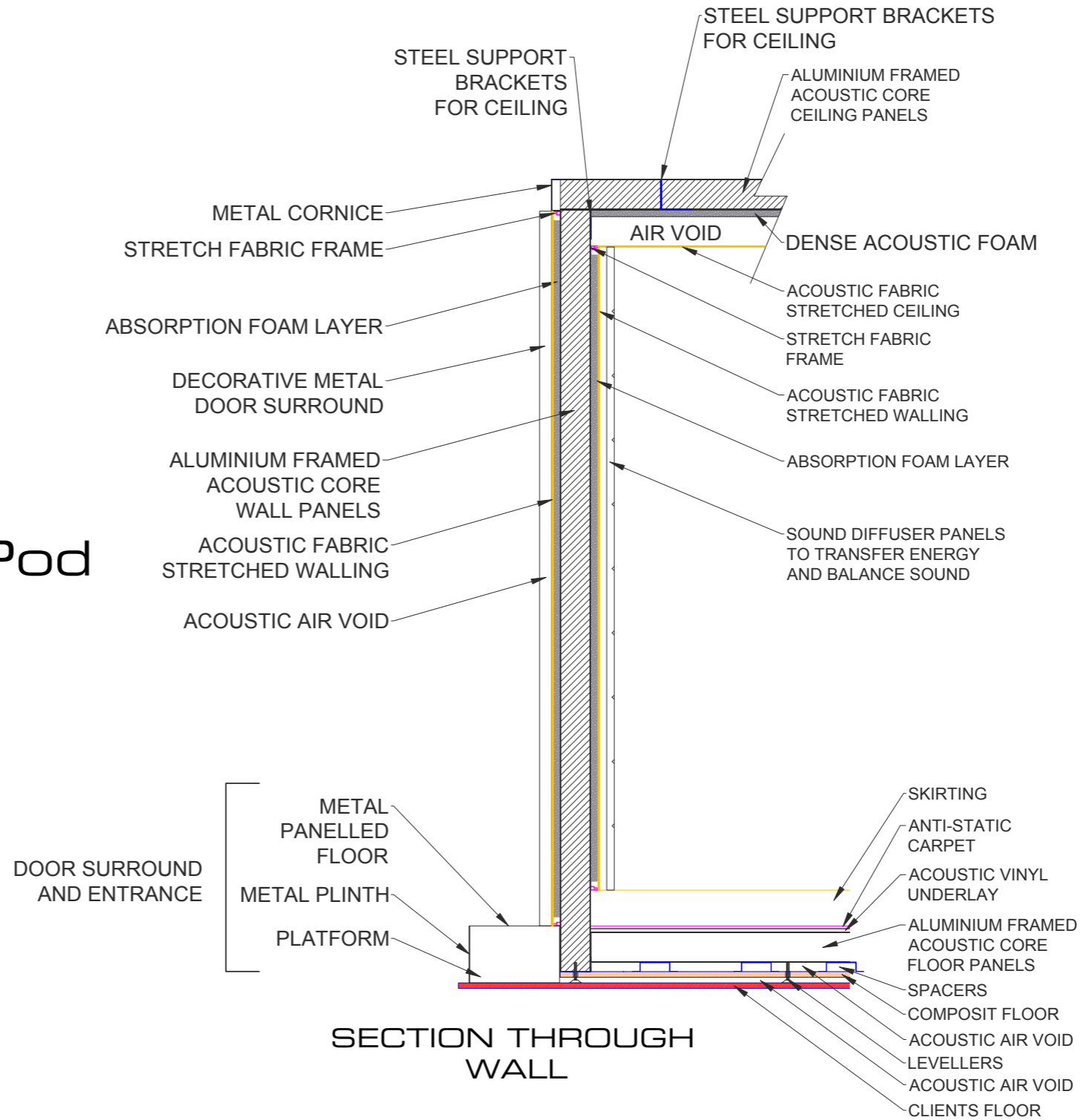

Section through Pod





Audio

- CIPOD's partners are 'Meridian Audio' a UK company, who are pioneers of high resolution and high performance audio and video solutions.
- The pod uses the Meridian 9.4.4 Dolby ATMOS theatre specification, designed to provide a deeply immersive audio-visual experience.
- The audio in the CIPOD delivers:
 - MQA (Master Quality Authenticated) which captures the original studio performance
 - Up Sampling which significantly enhances the listening experience by using a double digit filter
 - MHR (Meridian High Resolution) gets the highest possible sound quality in playback systems by combining high bandwidth, security and low jitter
- Each CIPOD comes with a minimum of eight speakers and four sub-woofers
- Full surround sound is achieved with in-wall front, side, rear and overhead speakers, positioned to provide the 'perfect audio' and low-frequency sound by the four sub-woofers positioned at the front and rear of the pod.



Visual

- A Barco Balder 'CinemaScope' projector provides incredibly deep, rich and crisp images, perfectly complimenting the Meridian audio theatre specification of the pod.
- Barco have a unique 80 year legacy that brings the ultimate in images to your CIPOD.
- The projection screen is a DT Screens Dynamic 2S slide masking screen. The screen uses fabric that is acoustically transparent and has very little effect on the sound reproduced. The image produced is full-screen.
- Pod's made form April 2018 will contain a 4K projector.



Intelligent Lighting and Power

- The lighting is an adaptable system that is interfaced with our bespoke control system. This enables any combination of lighting package to be connected and controlled to suit all preferences.
- The latest in LED technology is employed, maximising energy efficiency without compromising lumen output and effect.
- Emergency lighting is provided in the event of power loss and can be linked to other third parties, such as fire alarm systems.
- The unique pre-manufacture process of the CIPOD means that it is pre-loomed via the safe and secure, plug and play. This means the whole system is connected by one external electrical feed.



Tonino Lamborghini
CASA



Formitalia
Luxury Interiors
Firenze - Italia



Produced and distributed by
FORMITALIA Luxury Group spa
Headquarters: via Corticella 5/7/9, 51039 Valenzatico (PT), Italy
tel.: +39 0573 790066 fax: +39 0573 734332
Gallery Firenze: Palazzo Nasi, Piazza de' Mozzi 4, 50125 Firenze
info@formitalia.it www.formitalia.it

Schematics

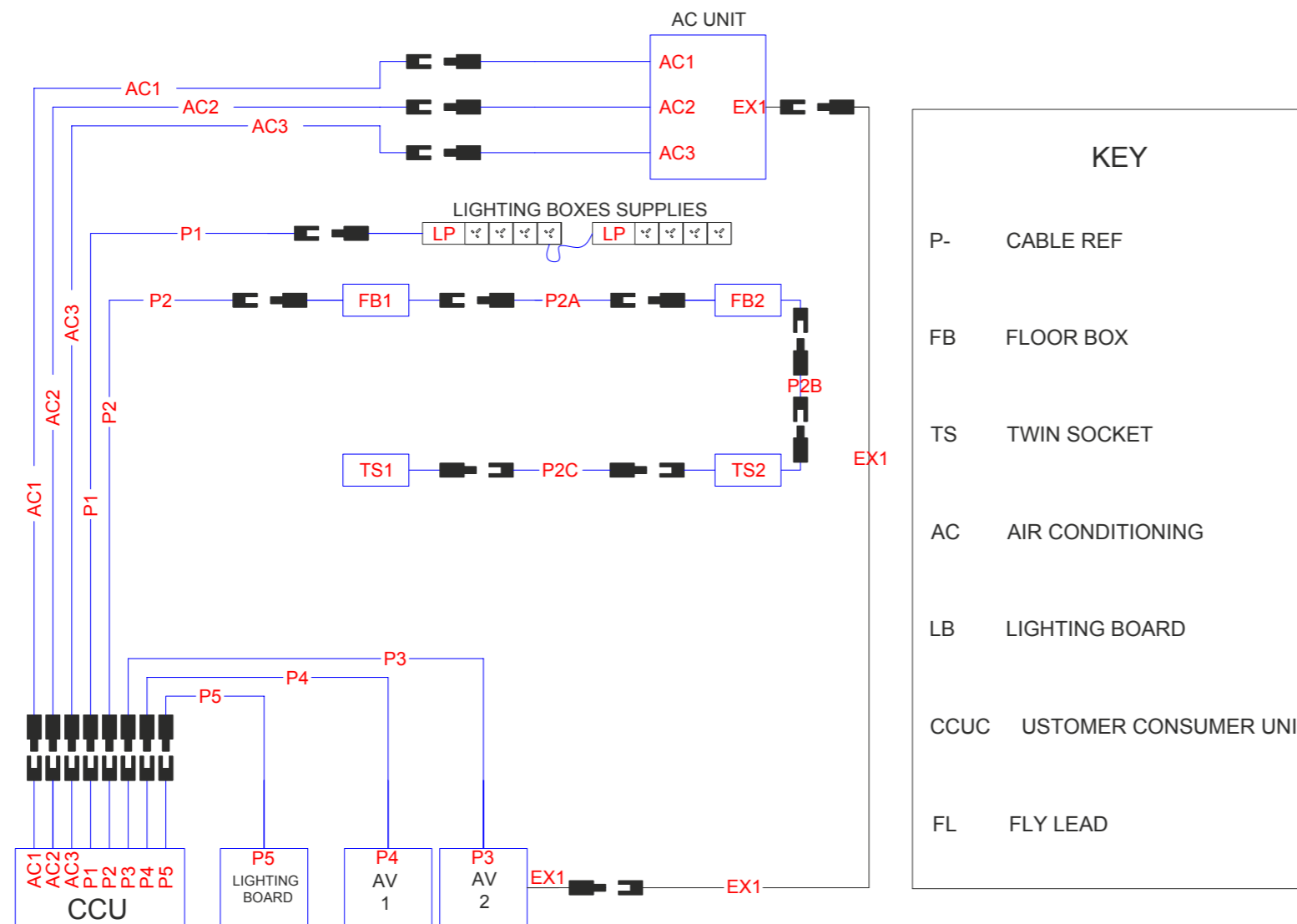

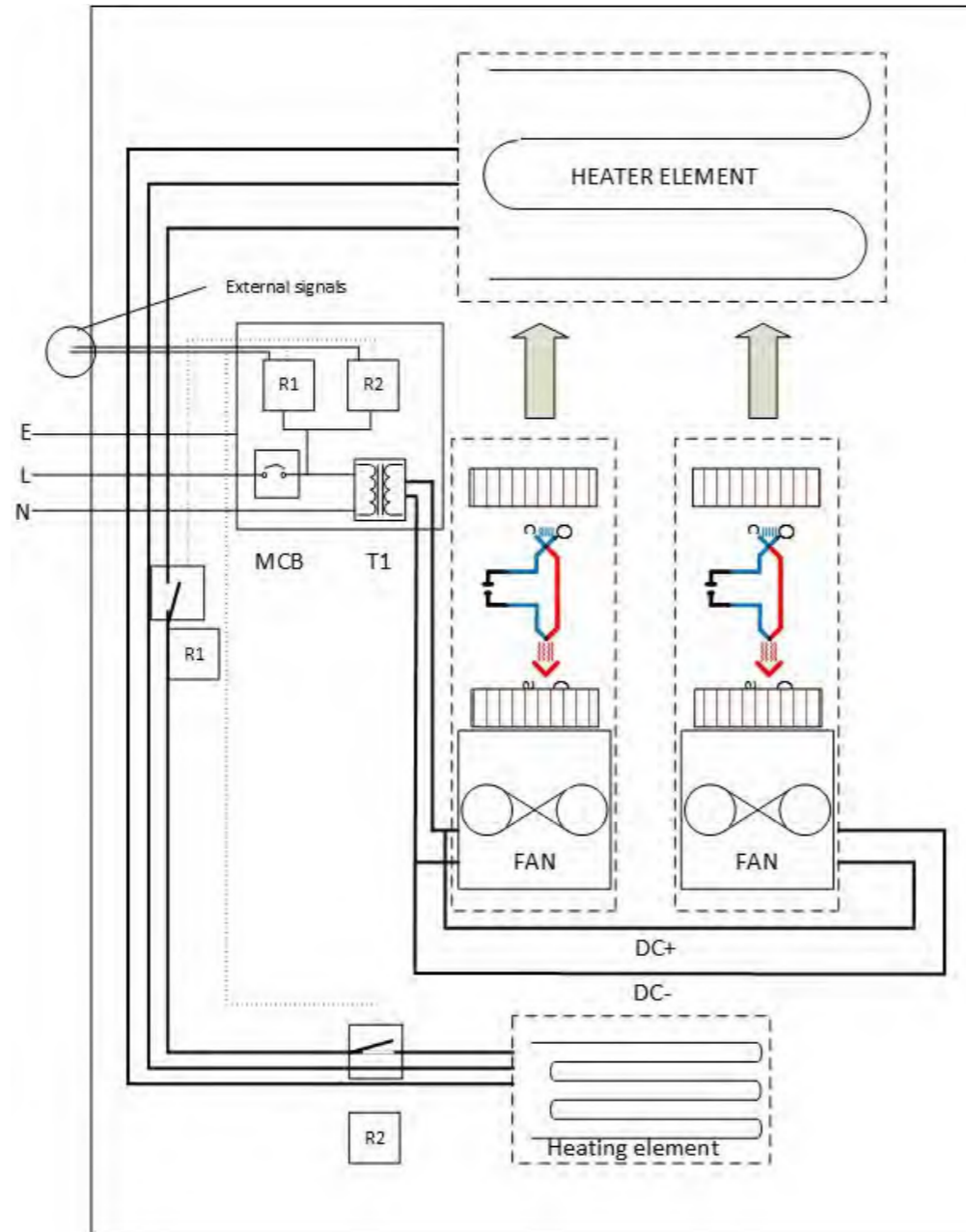

Environmental

- The CIPOD has a patented silent air cooling/heating system known as the Combi E cooler, designed exclusively for our Pods.
- The CIPOD Climate Control unit is one of the most advanced cooling in the world and because it does not refrigerate it is very environmentally-friendly.
- The attenuators are strategically placed throughout the cinema. This allows the air path to be precisely directed to deliver a constant, gentle flow of cooled or heated air into the whole of the cinema without creating drafts and cold spots – as with traditional air conditioning systems.
- Safety is a prime concern, so with that in mind all of the items within the CIPOD Climate Control unit operate from a 24 volt dc low voltage transformer, which is classed as a safe voltage.
- Filtered Routers deliver ambient air into the system. One for processing, the other delivers air from within the pod itself for processing. This ensures that conditioned air is delivered back into the cinema in a clean, fresh condition.



Intelligent systems

- All of the systems in a CIPOD are controlled through a state-of-the-art Crestron home automation system.
- You can control everything in your CIPOD through the Crestron system and all from a single device – lighting, climate control, doors and every entertainment service (including services like Sky and Netflix) and device (like X-box) imaginable.
- The Crestron system allows you to create different modes, depending on how you are using your CIPOD. For example Movie Mode might dim the lights and configure the screen to display the film as you would at the movies.
- All of your entertainment systems can be added through our excellence package, such as Sky box, Apple TV, X-Box and digital theatre controllers, are all contained in a beautifully designed credenza at the front of the cinema below the screen. Ensuring that your viewing pleasure is not disturbed by the various lights they emit.



CIPOD Technical Concierge

- Your CIPOD comes with a Technical Concierge service providing round the clock support and advice. Whether it's a quick fix before you start a film, or you need one-2-one support on a more complex problem, CIPOD Concierge ensures you get the best from your cinema.



Tonino Lamborghini
CASA



Formitalia
Luxury Interiors
Firenze - Italia

Work Examples

HOME CINEMA

Tonino Lamborghini
CASA

Formitalia
Luxury Interiors
Firenze - Italia



Produced and distributed by
FORMITALIA Luxury Group spa
Headquarters: via Corticella 5/7/9, 51039 Valenzatico (PT), Italy
tel.: +39 0573 790066 fax: +39 0573 734332
Gallery Firenze: Palazzo Nasi, Piazza de' Mozzi 4, 50125 Firenze
info@formitalia.it www.formitalia.it



Tonino Lamborghini
CASA



Formitalia
Luxury Interiors
Firenze - Italia



Produced and distributed by
FORMITALIA Luxury Group spa
Headquarters: via Corticella 5/7/9, 51039 Valenzatico (PT), Italy
tel.: +39 0573 790066 fax: +39 0573 734332
Gallery Firenze: Palazzo Nasi, Piazza de' Mozzi 4, 50125 Firenze
info@formitalia.it www.formitalia.it

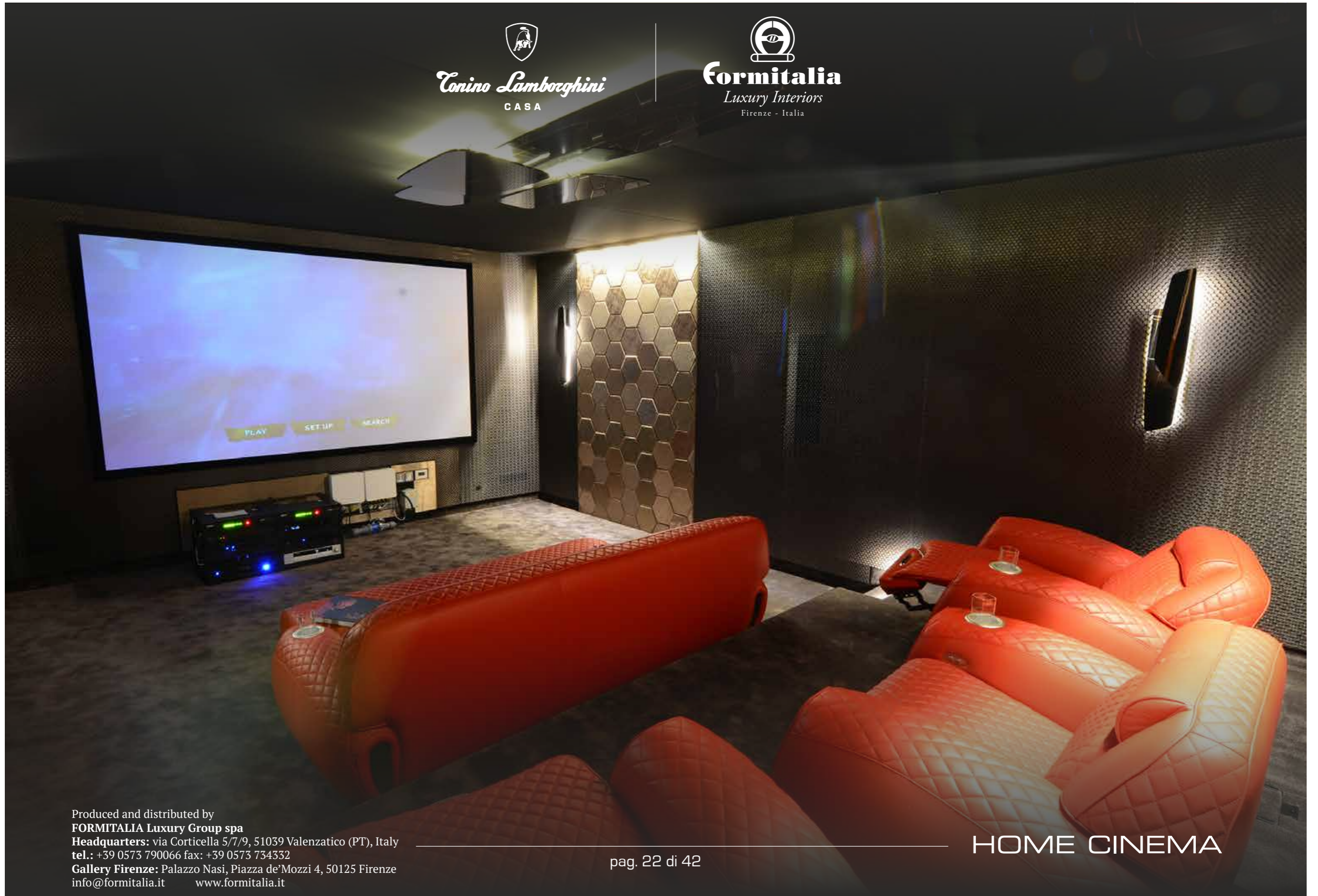



Tonino Lamborghini
CASA



Formitalia
Luxury Interiors
Firenze - Italia



Produced and distributed by
FORMITALIA Luxury Group spa
Headquarters: via Corticella 5/7/9, 51039 Valenzatico (PT), Italy
tel.: +39 0573 790066 fax: +39 0573 734332
Gallery Firenze: Palazzo Nasi, Piazza de' Mozzi 4, 50125 Firenze
info@formitalia.it www.formitalia.it

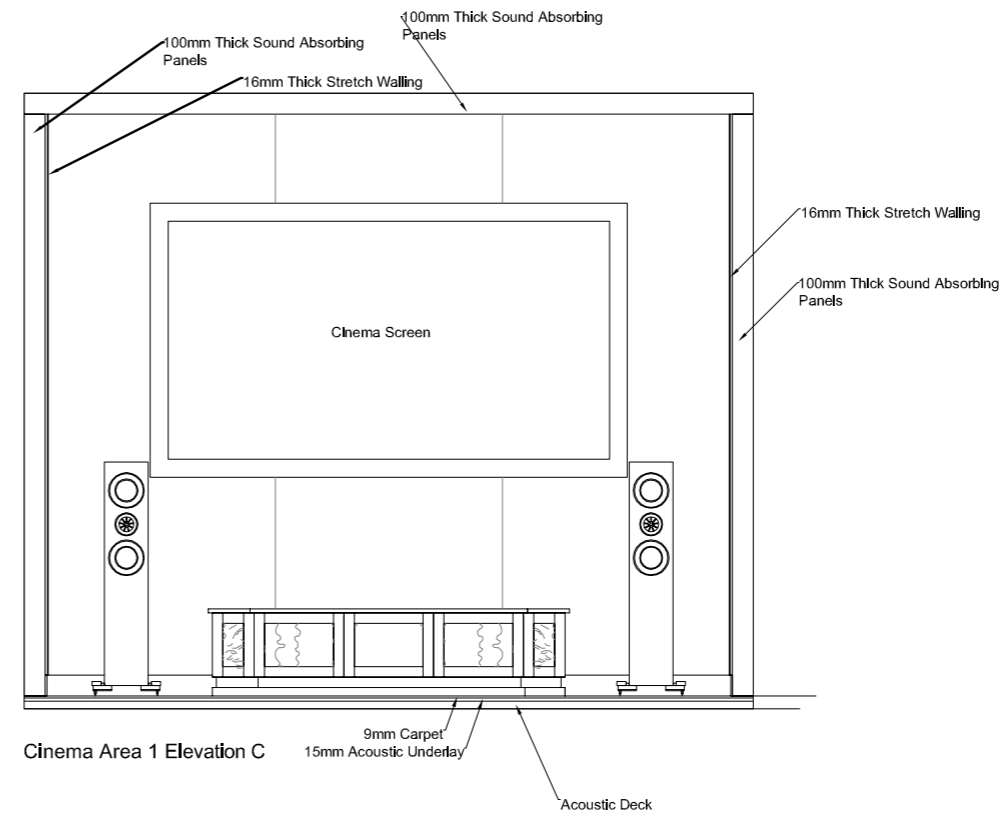
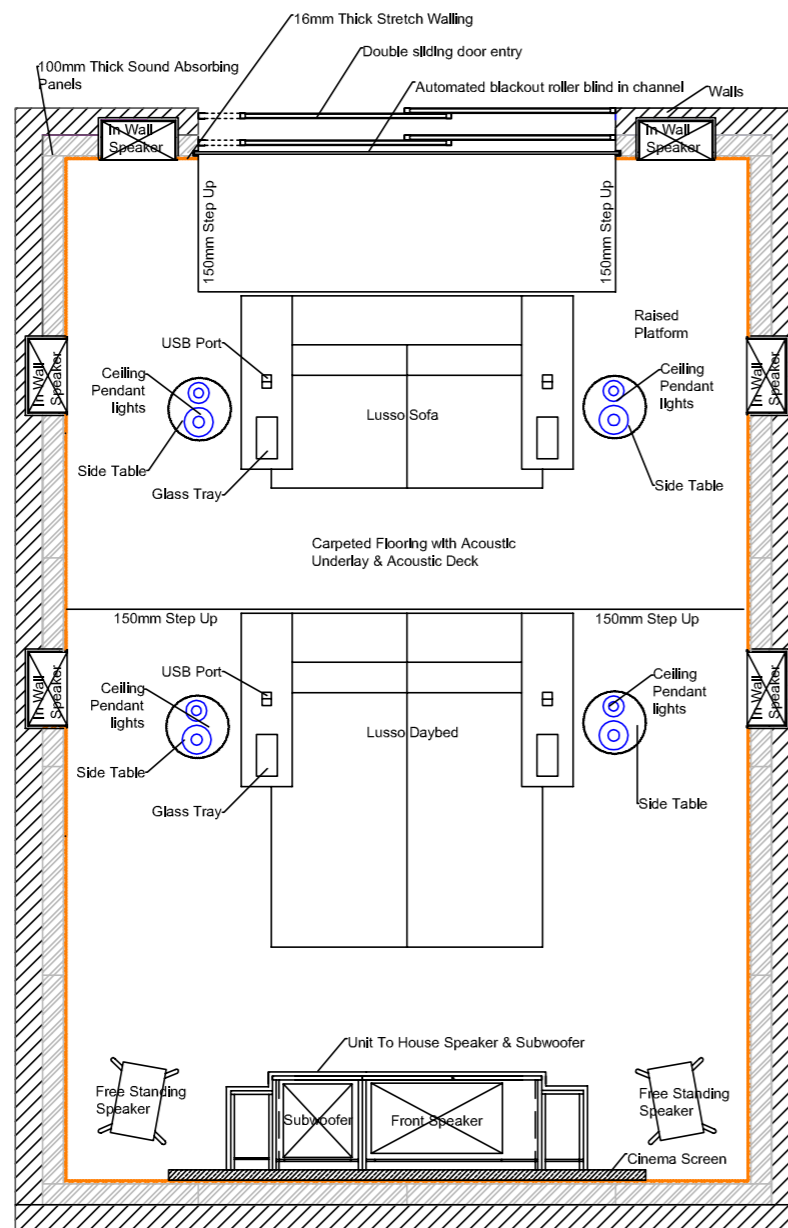





















Tonino Lamborghini
CASA



Formitalia
Luxury Interiors
Firenze - Italia

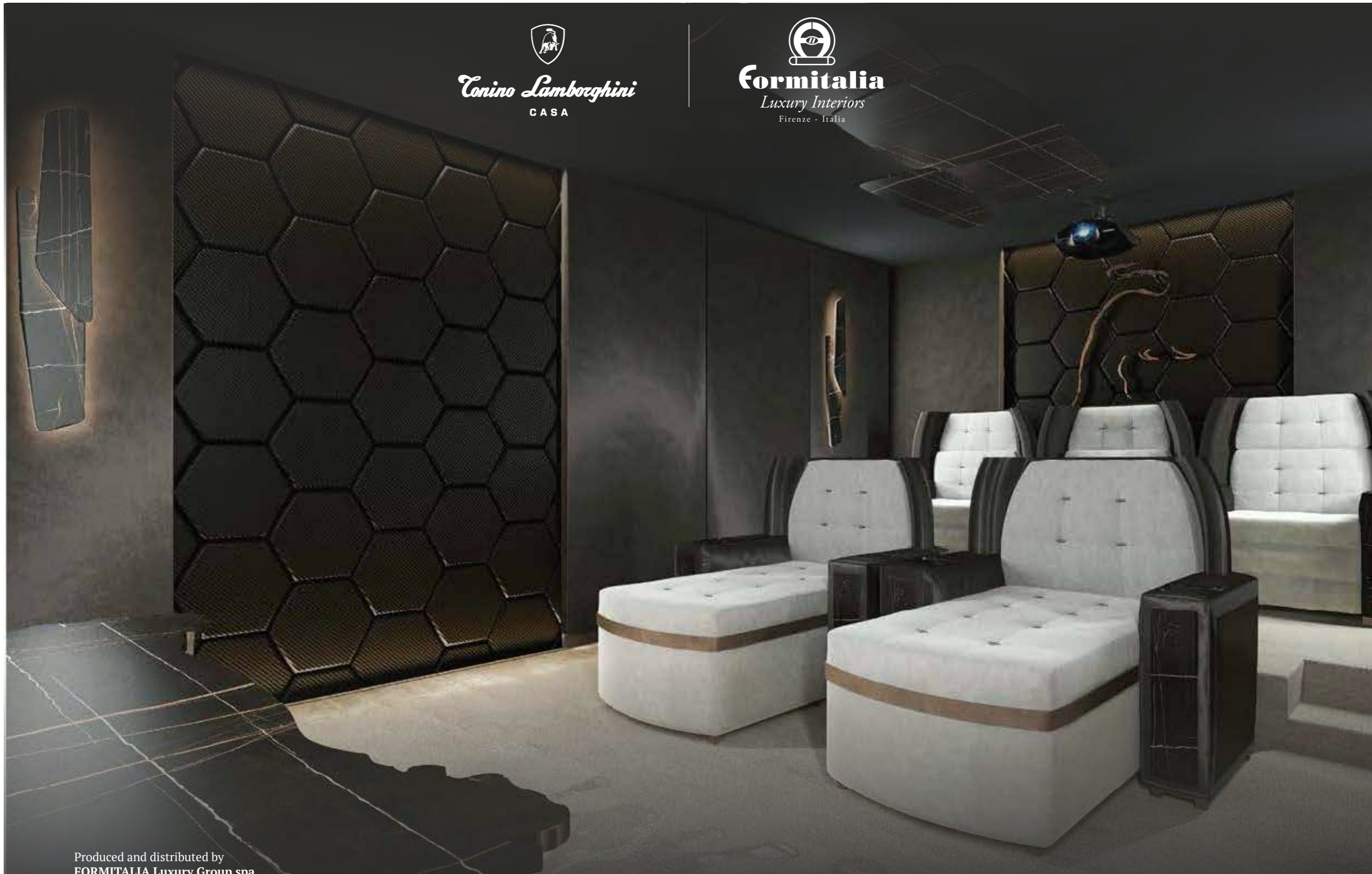

Produced and distributed by
FORMITALIA Luxury Group spa
Headquarters: via Corticella 5/7/9, 51039 Valenzatico (PT), Italy
tel.: +39 0573 790066 fax: +39 0573 734332
Gallery Firenze: Palazzo Nasi, Piazza de'Mozzi 4, 50125 Firenze
info@formitalia.it www.formitalia.it





Tonino Lamborghini
CASA



Formitalia
Luxury Interiors
Firenze - Italia

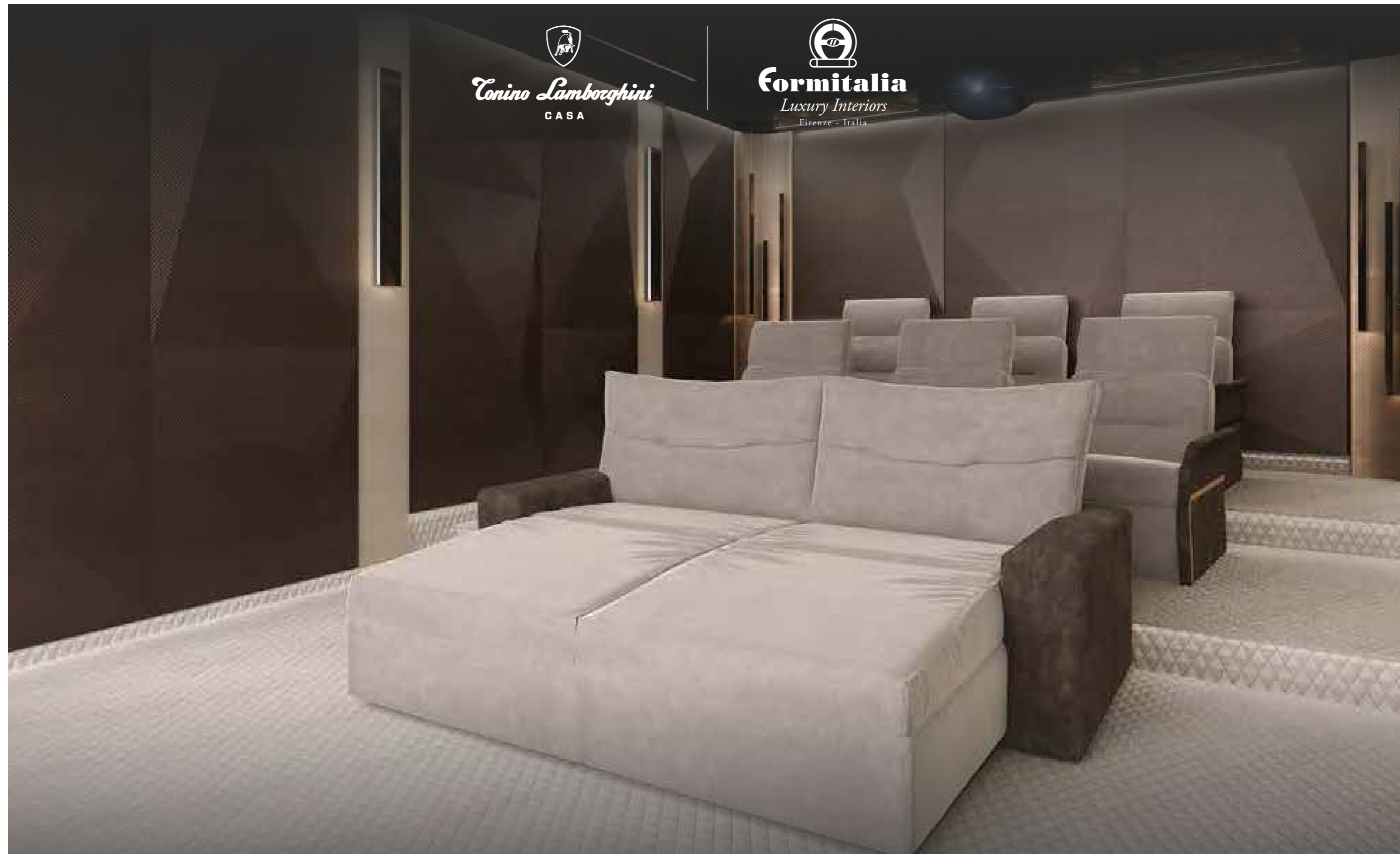

Produced and distributed by
FORMITALIA Luxury Group spa
Headquarters: via Corticella 5/7/9, 51039 Valenzatico (PT), Italy
tel.: +39 0573 790066 fax: +39 0573 734332
Gallery Firenze: Palazzo Nasi, Piazza de'Mozzi 4, 50125 Firenze
info@formitalia.it www.formitalia.it



Tonino Lamborghini
CASA



Formitalia
Luxury Interiors
Firenze - Italia



Produced and distributed by
FORMITALIA Luxury Group spa
Headquarters: via Corticella 5/7/9, 51039 Valenzatico (PT), Italy
tel.: +39 0573 790066 fax: +39 0573 734332
Gallery Firenze: Palazzo Nasi, Piazza de'Mozzi 4, 50125 Firenze
info@formitalia.it www.formitalia.it



Tonino Lamborghini
CASA



Formitalia
Luxury Interiors
Firenze - Italia



Produced and distributed by
FORMITALIA Luxury Group spa
Headquarters: via Corticella 5/7/9, 51039 Valenzatico (PT), Italy
tel.: +39 0573 790066 fax: +39 0573 734332
Gallery Firenze: Palazzo Nasi, Piazza de'Mozzi 4, 50125 Firenze
info@formitalia.it www.formitalia.it



Tonino Lamborghini
CASA



Formitalia
Luxury Interiors
Firenze - Italia



Produced and distributed by
FORMITALIA Luxury Group spa
Headquarters: via Corticella 5/7/9, 51039 Valenzatico (PT), Italy
tel.: +39 0573 790066 fax: +39 0573 734332
Gallery Firenze: Palazzo Nasi, Piazza de' Mozzi 4, 50125 Firenze
info@formitalia.it www.formitalia.it



Tonino Lamborghini
CASA



Formitalia
Luxury Interiors
Firenze - Italia

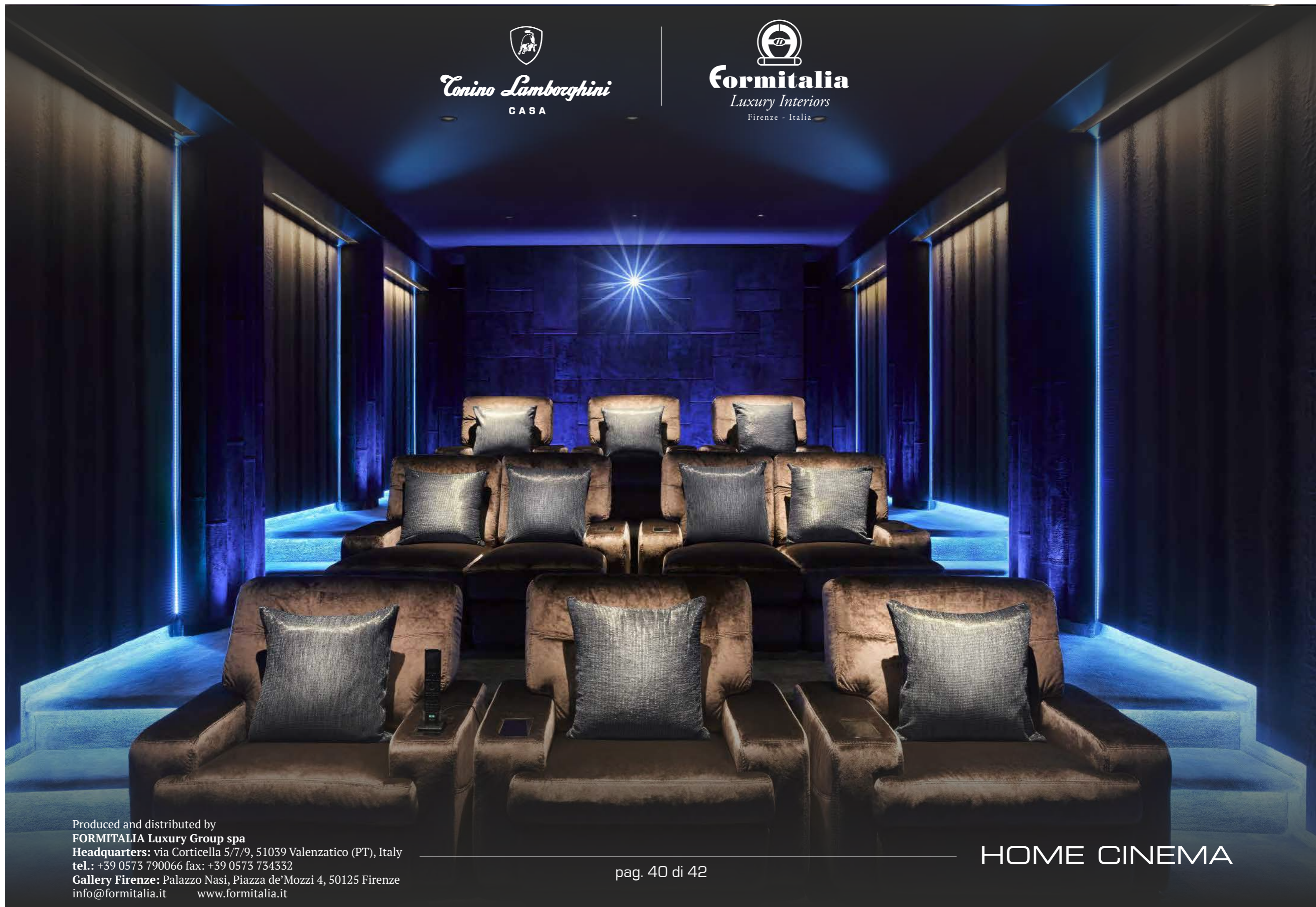

Produced and distributed by
FORMITALIA Luxury Group spa
Headquarters: via Corticella 5/7/9, 51039 Valenzatico (PT), Italy
tel.: +39 0573 790066 fax: +39 0573 734332
Gallery Firenze: Palazzo Nasi, Piazza de' Mozzi 4, 50125 Firenze
info@formitalia.it www.formitalia.it



Tonino Lamborghini
CASA



Formitalia
Luxury Interiors
Firenze - Italia



Produced and distributed by
FORMITALIA Luxury Group spa
Headquarters: via Corticella 5/7/9, 51039 Valenzatico (PT), Italy
tel.: +39 0573 790066 fax: +39 0573 734332
Gallery Firenze: Palazzo Nasi, Piazza de'Mozzi 4, 50125 Firenze
info@formitalia.it www.formitalia.it



Tonino Lamborghini

C A S A



Formitalia[®]
Luxury Group

Luxury Interiors and Accessories for Exclusive Homes, Hotels, Executive Offices & Yachts
info@formitalia.it www.formitalia.it